

# Navlakhi's

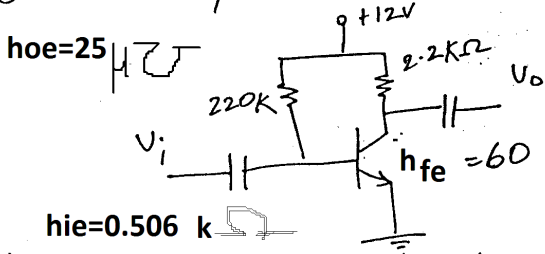

Tel: 23868356 / 23886023 / 9820246760 **POWER**

① Find Q-point,  $Z_o$ ,  $Z_i$ ,  $A_v$ ,  $A_i$



② Find  $V_{cc}$  if  $A_v = -200$

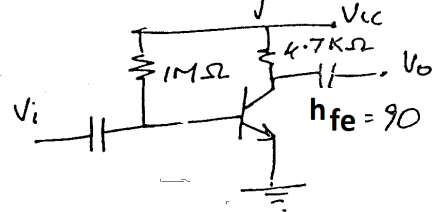

③ Find Q-point,  $Z_o$ ,  $Z_i$ ,  $A_v$ ,  $A_i$

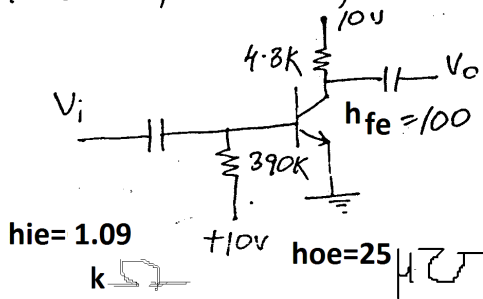

④ Find Q-point,  $Z_o$ ,  $Z_i$ ,  $A_v$ ,  $A_i$

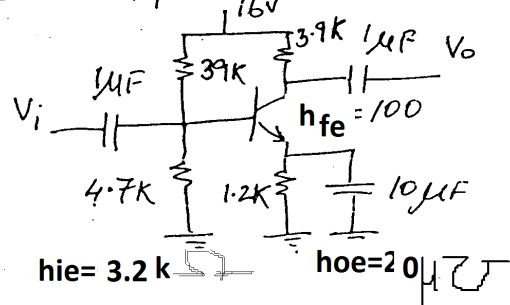

⑤ Find  $V_{cc}$  if  $A_v = -160$

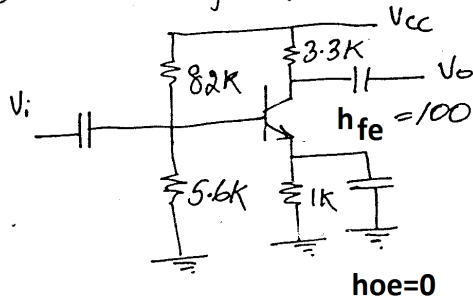

⑥ Find Q-point,  $Z_o$ ,  $Z_i$ ,  $A_v$ ,  $A_i$

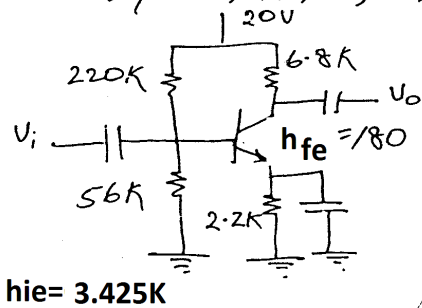

⑦ Find Q-point,  $Z_o$ ,  $Z_i$ ,  $A_v$ ,  $A_i$

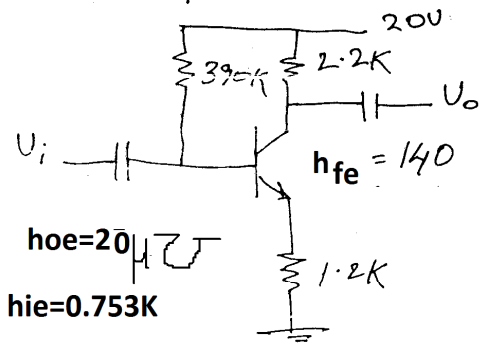

⑧ Find  $R_E$  &  $R_B$  if  $A_v = -10$

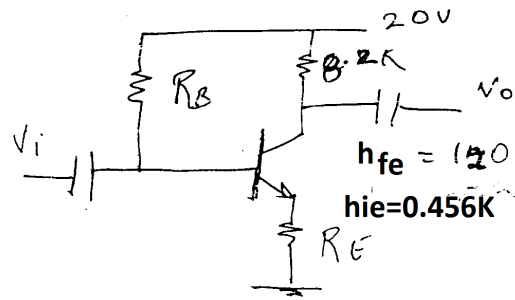

9820246760 / 9769479368

navlakhi.com | navlakhi.mobi



ref: 23868356 / 23886023 / 9820246760 **POWER**

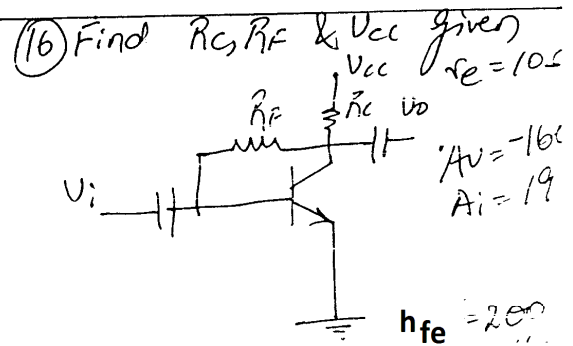
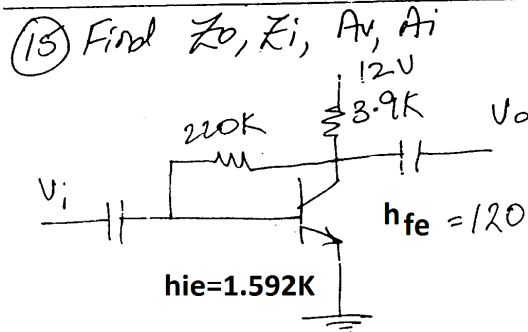
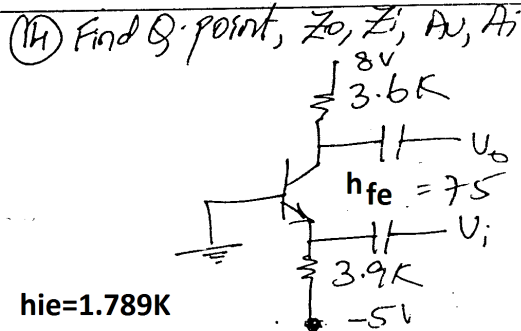
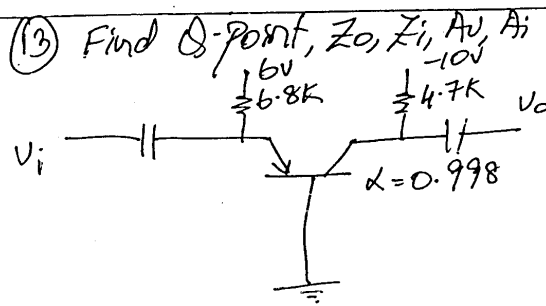
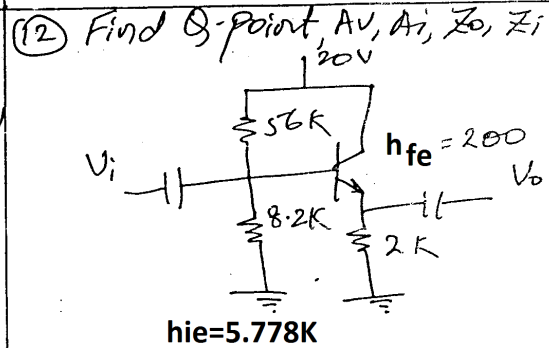
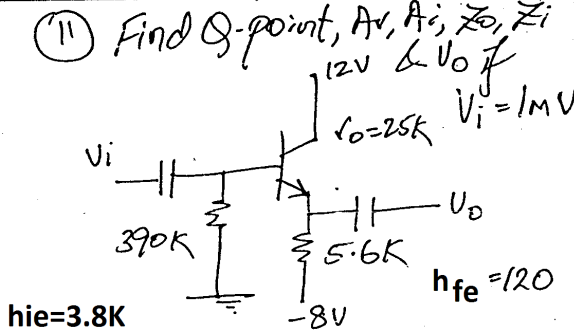
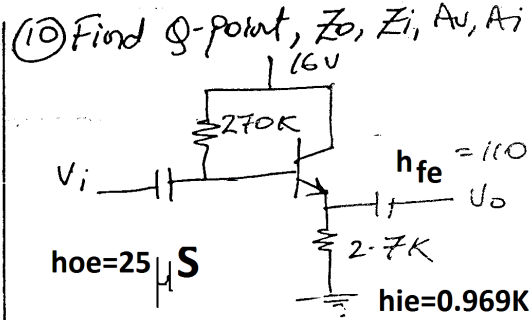
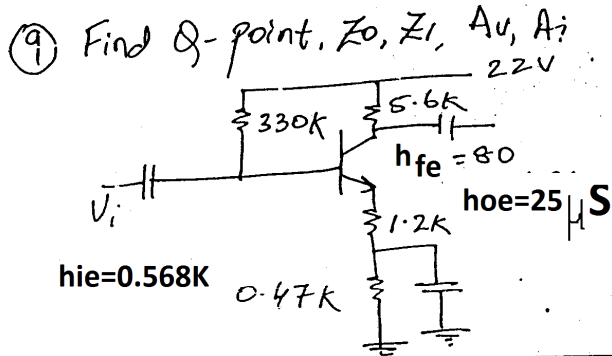



(17) Find Q-point,  $Z_o$ ,  $Z_i$ ,  $A_v$ ,  $A_i$

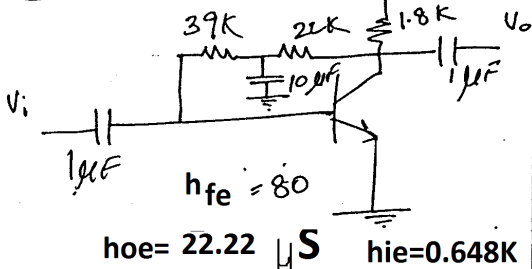

(18) Find Q-point,  $Z_o$ ,  $Z_i$ ,  $A_v$ ,  $A_i$

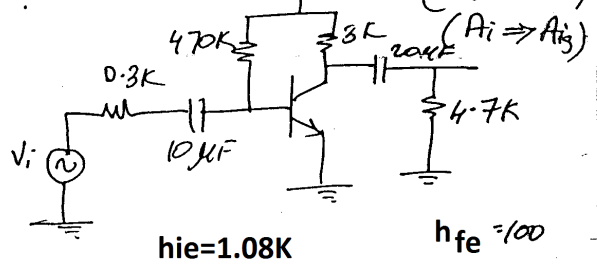

(19) Find Q-point,  $Z_o$ ,  $Z_i$ ,  $A_v$ ,  $A_i$

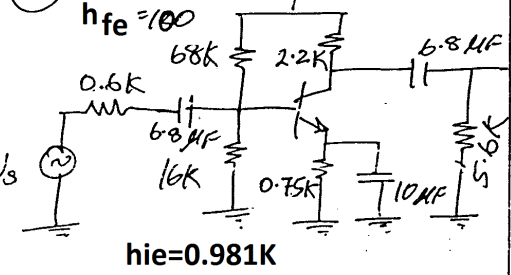

(20) Find Q-point,  $Z_o$ ,  $Z_i$ ,  $A_v$ ,  $A_i$

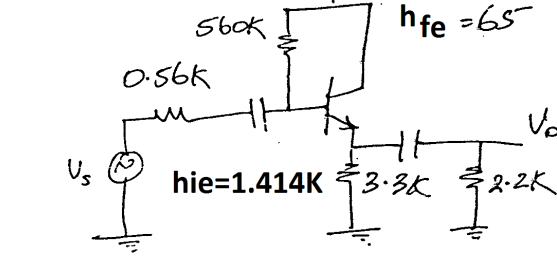

(21) Find Q-point,  $Z_o$ ,  $Z_i$ ,  $A_v$ ,  $A_i$

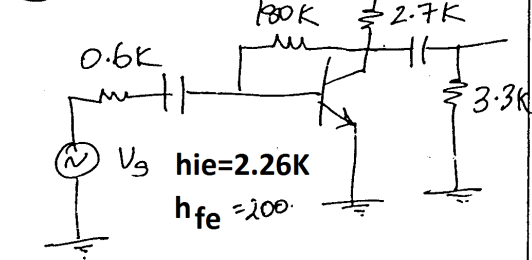

(22) Find Q-point,  $Z_o$ ,  $Z_i$ ,  $A_v$ ,  $A_i$

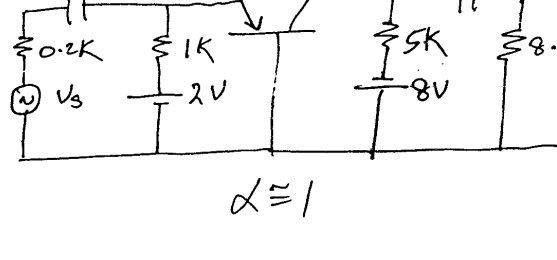

(23) Find Q-point,  $Z_o$ ,  $Z_i$ ,  $A_v$ ,  $A_i$

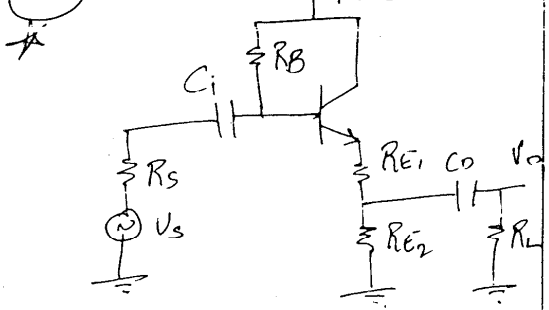

(24) Find Q-point,  $Z_o$ ,  $Z_i$ ,  $A_v$ ,  $A_i$

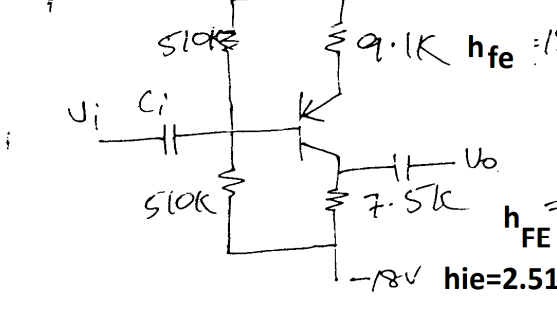

9820246760 / 9769479368

navlakhhi.com | navlakhhi.mobi